

SP7

Solar Home System Kit

OLYS

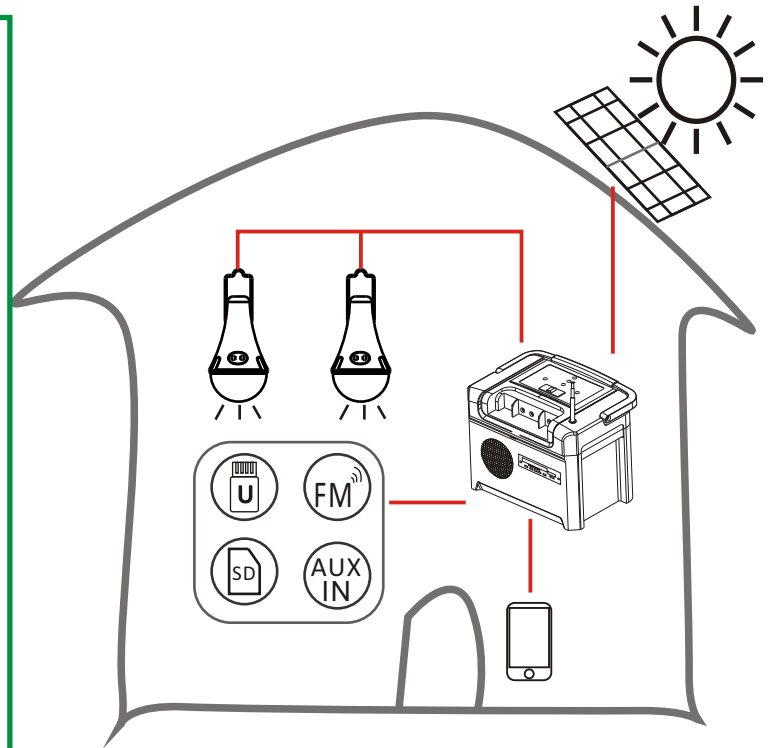

The new design of the solar kit, SP7 integrates the solar lighting, MP3 player, FM radio, mobile phone charging, and other functions
 LED Brightness, lighting time, charge control, battery capacity, working times and other aspects have a great improvement, widely used in home, outdoor lighting and entertainment

LED Lamp



Different LED Lamp

LED lamp have appearance patents, significantly more than the traditional size of the ball lamp with a stainless steel hook, easy to use, high quality, ensure that the brightness, And life, brightness is greater than 200LM , comes with 5 meter light line, with the standard 2.1/5.5mm DC plug is convenient, You put the lights in any place you want

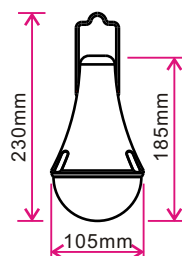

normal Lamp



NOTE:

2 lamp/set
 Can also be ordered separately

Brightness contrast

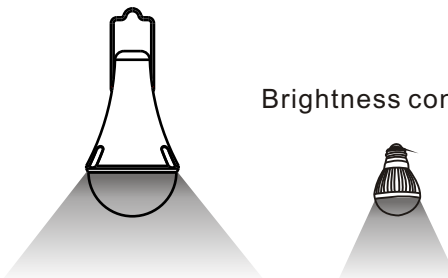

Battery

High-capacity

Using the domestic brand original maintenance free sealed lead-acid battery, specifications: 7AH/12V. Capacity up to 84WH. equivalent to 12PCS 18650 lithium battery, the service life of up to 5 years

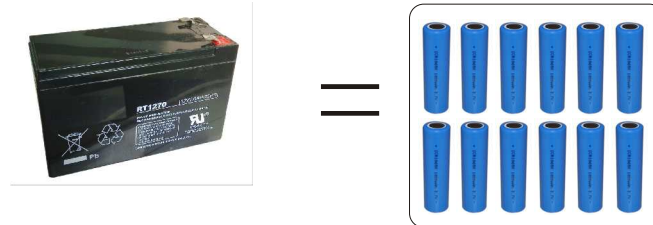

Working time

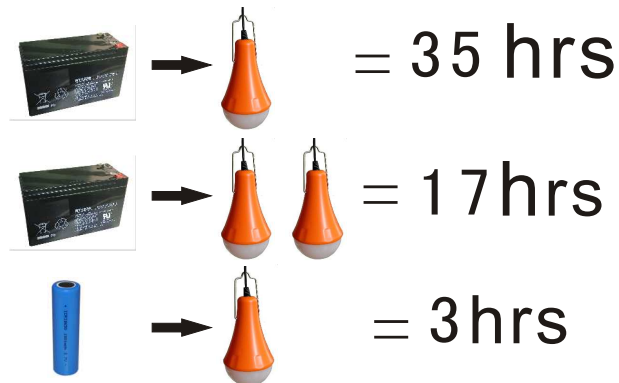

Solar charge controller

Intelligent charge control technology



Charging controller has been the core technology of the solar system. This system adopts USA microchip MCU, intelligent PWM charge and discharge controller technology to ensure that the system in charge and discharge are in the best technical state.

System in the use of security aspects of a comprehensive upgrade, with a variety of protective functions, Battery over charge protection, over discharge protection, overload protection, Reverse protection, short circuit protection. Over temperature protection. To ensure that customers are in any situation Safe



MCU



Charge technology



Protection

FM/MP3 Player



FM



Play U disk



Play SD card



AUX IN

Multifunctional entertainment system

The system integrates a variety of entertainment systems, including FM radio, MP3 player(including play U disk, play SD card MP3 Music), and audio input function, Long working hours, no longer have to worry about no electricity.



Working time:

FM radio=55hrs

Play U disk=35hrs

Play SD card=55hrs

AUX IN =55hrs

Solar panel

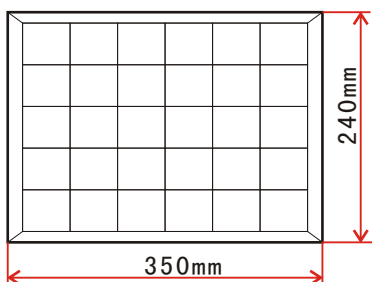

High efficiency solar panel

Using 10W/17.5V high efficiency polycrystalline silicon solar panels, can be fast charge to the system, charging time 8-10 hours, Aluminum alloy frame, to ensure that the solar panel is longer life than the plastic frame.Covering the high transparent glass.

Equipped with 5 meters DC wire, to ensure that the user can put the board in the light of the sun

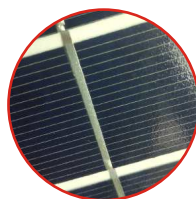

High efficiency Aluminum alloy frame 5M charge wire

Parts name

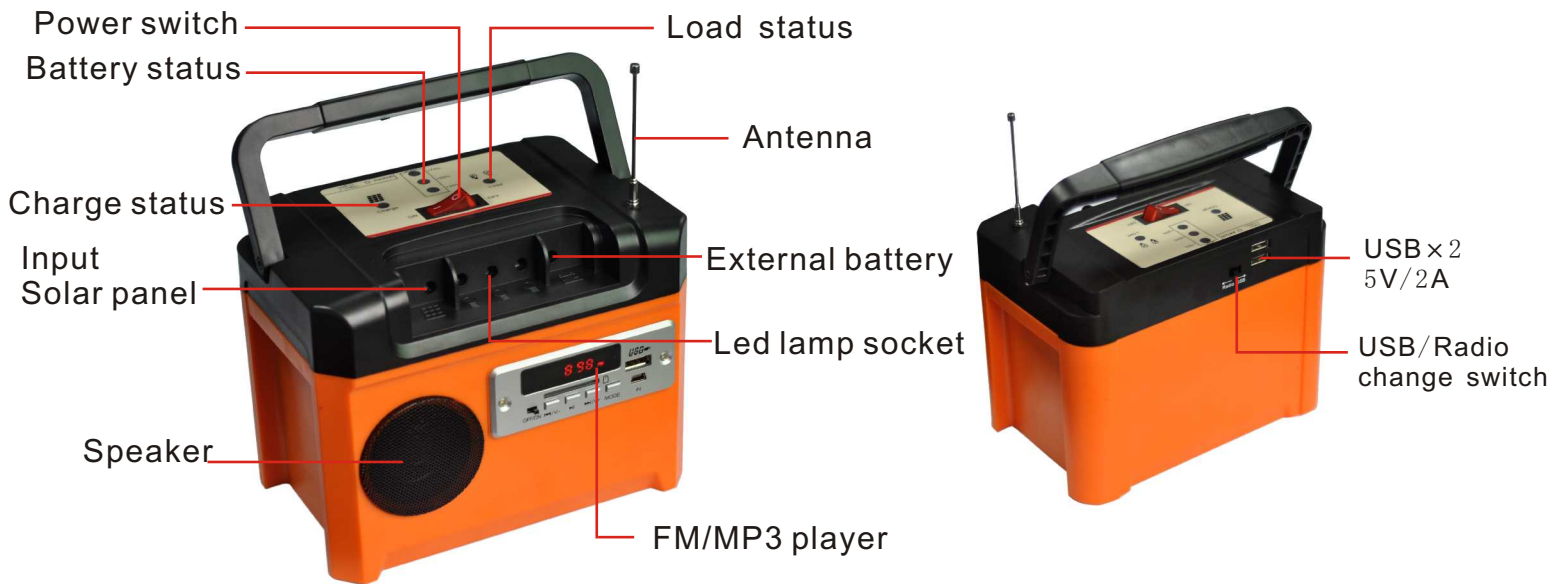

LED lamp



Phone charge



FM/MP3 player



Lamp Socket



status LED

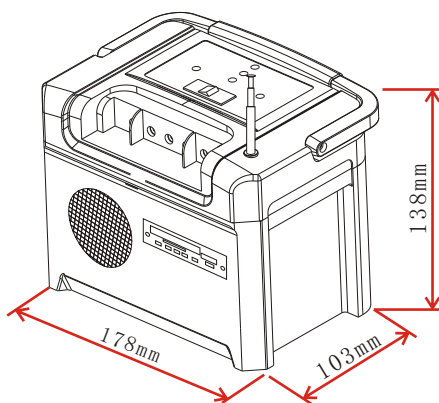

Packaging information

Color box:	370×190×260mm
Packing box (3set) :	570×390×280mm
Net weight (1 set) :	4.5kg
Gross weight (1set) :	5kg
20 feet cabinet quantity:	1300set

Parameter

Model	SP7
Build-in battery	12V/7AH
Solar power	10W/17.5V
Max.charge current	2A
Max.discharge current	5A
Output voltage	DC12V
Output socket	DC2.0mm
Output usb	DC5V/2.1A
External battery	12V
Size	178*103*138mm
Weight	2.5kg
Work temprature	-20°C-40°C